

FOR TRENDSETTERS



458



FOR TREND SETTERS

Die neue HANSE 458 ist die Yacht für alle, die Trends nicht folgen, sondern selber Trendsetter sind. Mit ihrem innovativen, zukunftsweisenden Design ist sie der Blickfang in jedem Hafen. Ihre außerordentliche Segelperformance imponiert Eignern und Gästen und lässt sie anderen immer ein paar Seemeilen voraus sein. Auch unter Deck setzt die HANSE 458 neue Maßstäbe. Mit einem modernen, exquisiten Interieur, das höchsten Ansprüchen an Stil und Lebensqualität gerecht wird. Freuen Sie sich auf exzellent durchdachten Luxus auf 45 Fuß.

The new HANSE 458 is a yacht for sailors who don't want to follow in the wake of the latest trend, but prefer to set their own course. With its innovative, pioneering design, this yacht is an eye-catcher in any harbour. And her excellent sailing performance is sure to thrill you while impressing both guests and the onlookers left astern. Below deck, too, the HANSE 458 sets new standards. Thanks to an exquisite, modern interior, she offers an effortlessly stylish and deeply comfortable life aboard.



Auf hoher See zu Hause. Die markanten schnellen Rumpflinien und der beeindruckende Segelplan stammen aus der Feder von judel/vrolijk & co, den besten und erfahrensten Yacht-konstrukteuren der Welt. Ebenso ist die Kombination aus perfekt abgestimmtem Lateralplan und vorbalanciertem Ruderblatt ein Garant für Schnelligkeit und Sicherheit.

Feel at home on the high seas. The trademark fast hull line and the impressive sail plan come from the pen of judel/vrolijk & co, the world's best and most experienced yacht construction engineers. The combination of a perfectly harmonised lateral plan and a pre-balanced rudder blade is a further guarantee for high-speed performance and safety while you are sailing.

FAST

CRUISING



Feel the pleasure of

COMFORT & SPEED

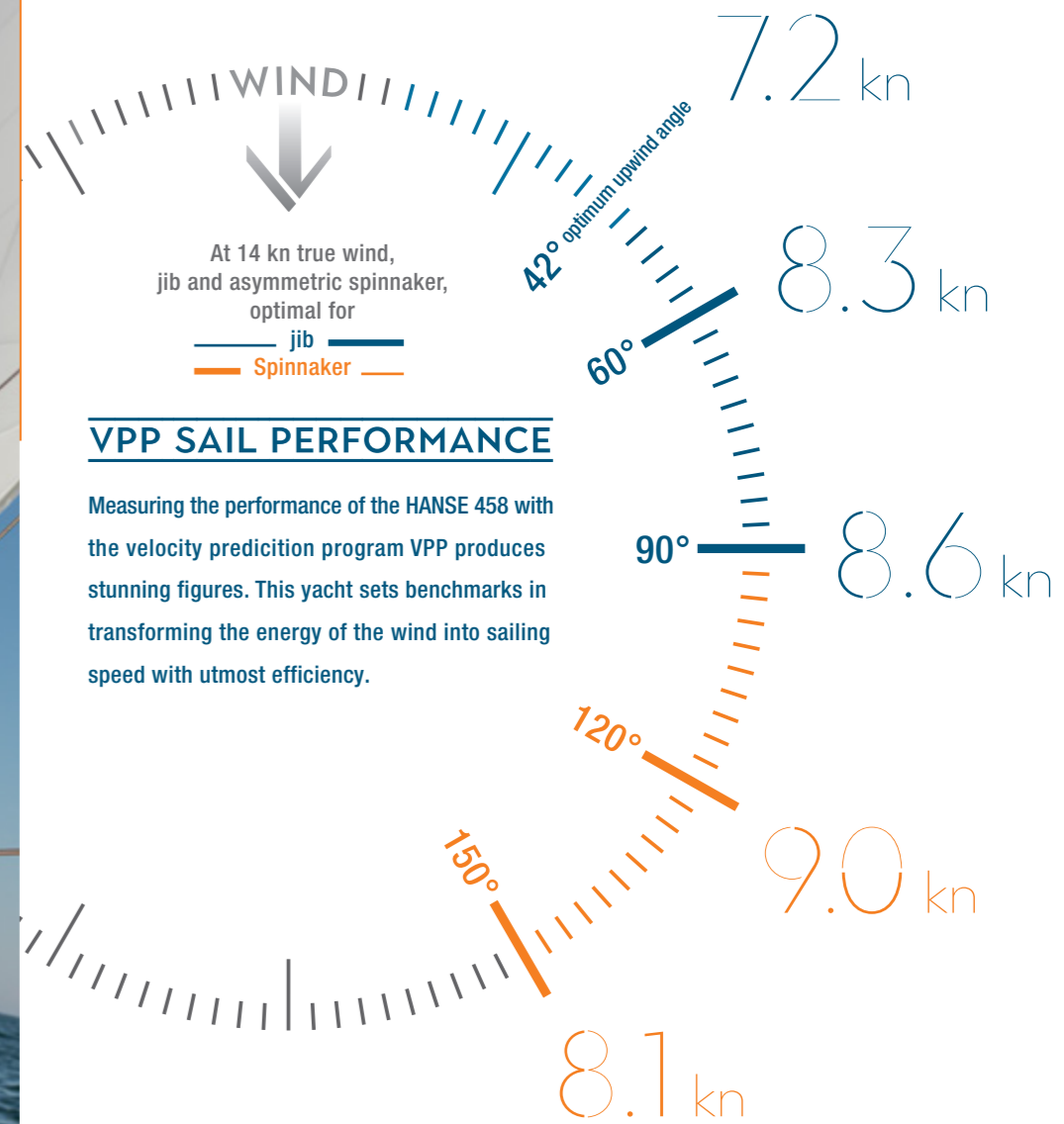

VPP SAIL PERFORMANCE

Measuring the performance of the HANSE 458 with the velocity prediction program VPP produces stunning figures. This yacht sets benchmarks in transforming the energy of the wind into sailing speed with utmost efficiency.

FAST CRUISING



RIG & SAIL OPTIMISATION

Ein hohes Rigg ist das Markenzeichen von HANSE. Die Yacht designer von judel/vrolijk & co passen den Segelplan mit hochentwickelten Berechnungsmodellen perfekt an jede HANSE an. Das garantiert beste Segeleigenschaften bei allen Bedingungen und macht eine HANSE zu der schnellsten Yacht in ihrer Klasse.

A high rig is the trademark of every HANSE. The yacht designers from judel/vrolijk & co perfectly form the sail plan for each HANSE with the use of highly sophisticated calculation models. This guarantees that you have the best sailing characteristics under all conditions, and it ensures your HANSE is one of the fastest yachts in its class.



0° heeling angle

15° heeling angle

CONSTANTLY LONG WATERLINE

Voraussetzungen für eine herausragende Performance sind das gerade Heck und der vertikale Steven. Dieses intelligente Design ermöglicht eine optimal lange Wasserlinie bei jedem Krängungswinkel – und damit eine überlegene Geschwindigkeit auf allen Kursen.

Outstanding performance comes from having a steep stern and a straight stem. This intelligent design provides an optimal, long waterline at any heeling angle – and superior speed for you on all courses.

FAST CRUISING



LOA
14.0 m

BEAM
4.4 m

DRAFT
2.2 m

DISPLACEMENT
17.7 t



HANSE SMART TRIM SYSTEM

Wir trimmen die Segel wie die Profis und setzen auf ein Achterstag, das sich stufenlos verstellen lässt. Damit können Mastbiegung und Profiltiefe der Segel jederzeit dem Wind angepasst werden.

We have trimmed the sail so you can sail like a pro and included a backstay, which can be adjusted seamlessly. This enables the mast and the profile of the sail to perfectly adapt to the wind at all times.



FAST CRUISING



Das HANSE Easy Sailing Concept ist legendär. Wir haben die integrierte Selbstwendefock konzipiert und alle Leinen zum Steuerstand geführt. So können Sie diese Yacht auch ganz alleine segeln. Das Reffen, Wenden und Segelsetzen erledigen Sie vom Steuerstand aus ganz ohne Anstrengungen. Das Deck ist kompromisslos frei von Leinen und Beschlägen, damit Sie unterwegs und im Hafen viel Platz zum Entspannen haben. So geht Segeln heute!

The HANSE Easy Sailing Concept is legendary. We invented the integrated self-tacking jib and brought all the lines to the helm. This means you can sail your yacht alone – or carefree while enjoying time with guests. Reefing, tacking and setting sail can all be performed from the helm without any effort. The deck is free of lines and fittings, giving you uncompromising comfort and space while you are at sea or relaxing in the harbour.

EASY SAILING



HANSE ONE-ROPE REEF SYSTEM

Sie bestimmen die Größe der Segelfläche – und das ganz bequem vom Cockpit aus. Das HANSE Einleinen-Reffsystem ermöglicht einfaches und schnelles Handling.

You decide the size of the sail area – easily from the comfort of the cockpit. The HANSE One-Rope Reef System ensures that handling is quick and effortless for you.

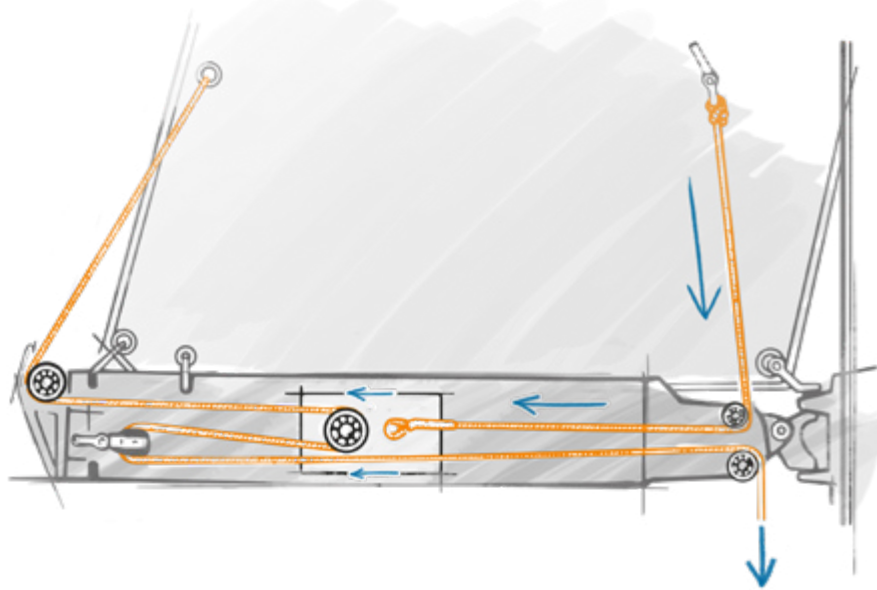

PURE DECK & COCKPIT

Clean und cool. Alle Flächen sind puristisch klar und aufgeräumt gestaltet. Die Fallen und Schoten verlaufen unsichtbar unter dem Deck.

Clean and cool. All spaces feature a minimalist design, with a pure and clear structure. We have even hidden the halyards and sheets elegantly below the deck.



HANSE SELF-TACKING JIB

Die Selbstwendefock ermöglicht einfache und schnelle Manöver. In der Wende oder Halse gleitet das Vorsegel über die integrierte Deckschiene von selbst auf die richtige Seite.

The self-tacking jib lets you easily and quickly manoeuvre the yacht. In the tack or the jibe, the headsail smoothly glides over the integrated deck rails automatically to the correct side.



EASY SAILING

HANSE RUDDER BALANCE

Beim Design der Ruderanlagen setzt HANSE kompromisslos auf Sicherheit bei gleichzeitiger Agilität. Deshalb haben wir ein vorbalanciertes Ruder entwickelt, dessen wirksame Oberfläche überdurchschnittlich groß ist. Damit lässt sich die Yacht in jeder Situation spielend leicht steuern.

When it comes to the design of the rudder system, HANSE gives you high agility without compromising safety. For this, we have developed a pre-balanced rudder whose efficient surface is larger than average. It makes steering the yacht in any situation child's play.

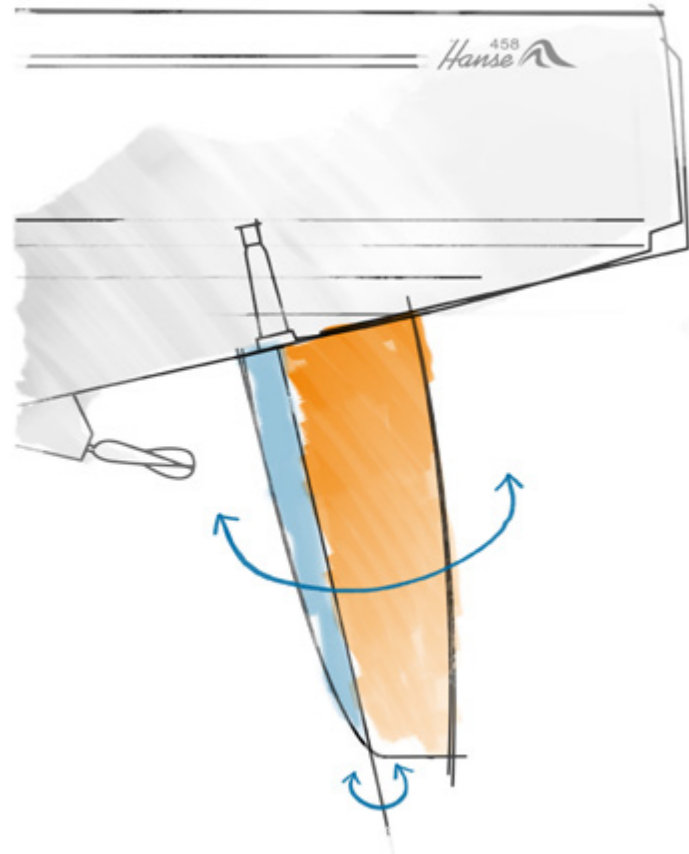

HANSE CROSSOVER SAIL

Das HANSE Crossover-Segel ist die eindrucksvolle Inszenierung eines ultramodernen Reachkurs-Segels, das mit feinsten Komponenten und technischem Know-how ausgestattet ist. Einzigartig ist die einfache Handhabung als Rollsegel sowie das enorme Einsatzspektrum von 65 bis 140 Grad zum Wind.

The HANSE Crossover Sail is the impressive result of an ultra-modern sail perfect for when you are on a reach course. Equipped with the finest components and technical finesses, this cutting-edge sail is unique in both its ease-of-use as a Genoa sail and its enormous spectrum of usage – from 65 to 140-degrees to the wind.

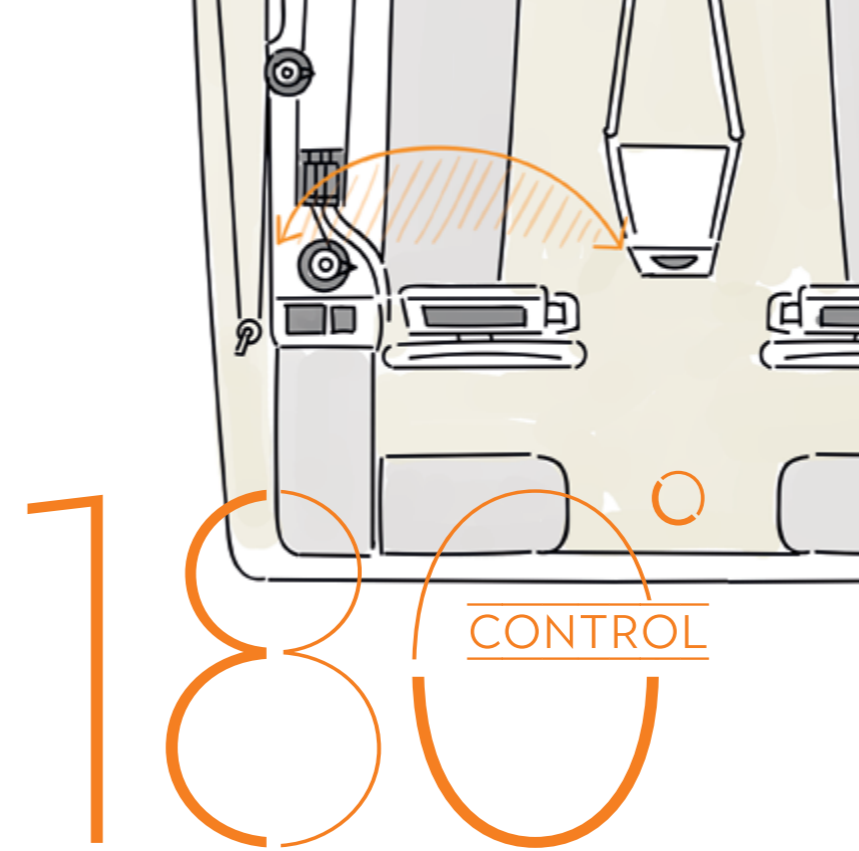

HANSE HELSMAN CONTROL

Segeln per Knopfdruck? Bei HANSE keine Vision, sondern Wirklichkeit! Steuern Sie die gesamte Technik bequem vom Cockpit aus. Alle Schoten und Fallen führen zum Steuerstand, somit haben Sie die absolute Kontrolle in allen Segelmanövern.

Sailing at the touch of a button? With HANSE, your dream is now reality! Control the entire system from the cockpit. All the halyards and sheets also lead to the helmsman. This gives you absolute control in all sailing manoeuvres.





In allem einen Schritt voraus. Technische Innovationen und Detailqualität sind ebenso ein Teil von HANSE wie emotionale Formensprache und Wohlfühlatmosphäre. Dabei setzt jedes Detail ein klares Design-Statement. Das perfekte Zusammenspiel von fortschrittlicher Technologie und ihrer Umsetzung im Design ist unser Anspruch an die perfekte Yacht.

With HANSE, you have a progressive yacht that makes a statement. Technical innovations and quality in every detail are just as much part of the HANSE 458 as are an emotional design and comfortable atmosphere of well-being. Each detail is a subtle expression of superior design. The well-orchestrated ensemble of advanced technology and its integration is the highest art of yacht design at HANSE – and what drives us to create the perfect yacht.



INNOVATIVE DESIGN



HIGH EXTERIOR&INTERIOR LIGHTS

1 Klappbare Badeplattform mit Teak 2 Steuermannssitze mit integriertem BBQ und Waschbecken 3 Doppelsteueranlage 4 Ergonomische Plotterpods 5 Glas-Skylights seitlich vom Niedergang 6 Sechs Rumpfenster 7 Dreizehn zu öffnende Decksluken 8 HANSE-Selbstwendefock 9 Skylights im Vorschiff 10 Helle, geräumige Achterkabinen 11 Exklusive neue Hölzer und Dekore 12 Moderne, vollausgestattete L-Pantry mit intelligentem, patentierten Kühlschrank, der von oben und von vorne zu öffnen ist 13 Kolorierte Oberschränke in trendigem Pearl Grey oder Dove Grey 14 Stilvoller Salon mit Loungesofas und elegantem, absenkbarem Salontisch 15 Hochwertige Wandverkleidung in Holzoptik 16 Luxuriöse Eignerkabine mit Kingsize-Inselbett, herrlich großen Skylights und viel Stauraum

1 Manuel fold-out Bathing platform with teak 2 Helmsmanseats with integrated BBQ and washbasin 3 Twin wheels 4 Ergonomic plotterpods 5 Glass skylights beside companionway 6 Six hull windows 7 Thirteen openable deck hatches 8 HANSE-self tacking jib 9 Skylights on fore deck 10 Bright and spacious aft cabins 11 Exclusive new woods and décors 12 Modern, fully equipped L-shaped pantry features an intelligent, patented fridge, which is openable from above and in the front 13 Coloured upper cupboards in a trendy Pearl Grey or Dove Grey tone 14 Stylish salon with elegant lounge sofas and lowerable table 15 High-quality wall panelling 16 Luxurious owner's cabin with king-size island bed, wonderful large skylights and enormous storage space

LIGHT & AIR Unlimited

Sich frei und wohl zu fühlen steht bei der HANSE 458 an erster Stelle. **1 & 2** Große Skylights im Vorschiff und dreizehn zu öffnende Decksluken sorgen unter Deck für ein von frischer Luft und Sonnenlicht durchflutetes Ambiente. **3** Das ganze Schiff wird zur Wohlfühloase, in der jeder seinen Lieblingsplatz findet. Sei es zum Erfrischen auf der Badeplattform, auf dem freien Deck in der Sonne oder geschützt mit einem sanften, kühlenden Luftzug im Salon.

Let the HANSE 458 deliver a sense of freedom and wellbeing that is hard to match. **1 & 2** Generous skylights in the bow and thirteen opening deck hatches allow light and fresh air to flood in below. **3** The entire yacht becomes your personal oasis of wellbeing – where everyone has a favourite spot. Be it the bathing platform for a refreshing dip, soaking up the sun on the spacious, open decks, or making the most of a gentle, cooling breeze in the saloon retreat.



INNOVATIVE DESIGN



Lifestyle pur: 1 Auf den stilvollen, komfortablen Polstern lassen sich Meer und Sonne wunderbar genießen. Die ergonomisch konzipierte Doppelsteueranlage macht das Steuern zum Vergnügen. 2 Mit dem integrierten BBQ und Waschbecken haben Sie Ihre Erfrischung stets griffbereit. 3 Große Skylights fügen sich perfekt in das klare, freie Layout des Decks ein. 4 Die clevere Leinenführung lässt sämtliche Leinen verschwinden.

Lifestyle without compromise: 1 Refined, comfortable cushions allow you to revel in the best the sea and sun can offer. The ergonomically designed twin wheels make for responsive, satisfying helming. 2 Thanks to the integrated barbecue and sink, you are never far from a fresco dining. 3 Large skylights seamlessly blend into the clear, open deck layout. 4 Our clever rope guide hides all sail controls for a tidy finish.



INNOVATIVE DESIGN



INNOVATIVE INTERIOR DESIGN

Wer es stilvoll und edel liebt, muss auf der HANSE 458 auf Nichts verzichten. Durch das innovative Lichtkonzept aus natürlichem Sonnenlicht und dimmbaren Akzenten genießen Sie eine einmalig wohltuende Atmosphäre. Der hochwertige Ausbau und die eleganten Lounge-Sofas bieten einen exzellenten Rahmen für geselliges Beisammensein ebenso wie für entspannte Stunden.

If you love style and elegance, you'll find your senses spoiled on the HANSE 458. Our innovative lighting concept makes the most of the sunlight and complements it with dimmable accent lights, to create a natural, relaxing atmosphere on board. The finely crafted interior with its elegant lounge sofas offers an excellent backdrop for a joyful get-together – or for serene moments alone.



INNOVATIVE GALLEY

Ganz nach Ihrem Geschmack: **1** Die moderne, intelligent konzipierte Pantry ist voll ausgestattet und gut zu belüften.
2 Die geräumigen Oberschränke können edel coloriert werden und fügen sich nahtlos in das wohnliche Ambiente ein.
3 Der von HANSE entwickelte Kühlschrank lässt sich von oben befüllen oder **4** praktisch von der Seite bestücken.

Just as you like it: **1** The modern, intelligently designed pantry is fully equipped and offers plenty of ventilation options.
2 The spacious cupboards can feature a range of harmonious colours to shape a cosy atmosphere that makes you feel perfectly at home. **3** The refrigerator, which has been specially designed by HANSE, can be easily accessed from the top or **4** conveniently from the side.



2



Alles perfekt. Für den perfekten Urlaub: **1** Die HANSE 458 kombiniert ein herrlich freies Wohngefühl mit einer außerordentlichen Wohlfühlatmosphäre aus stimmungsvoller Farbgestaltung und akzentuierendem Lichtkonzept. Flexibel nutzbarer Raum erfüllt alle Bedürfnisse. **2** Formschönes Design und indirektes Licht machen das Bad zu einem Ort der Entspannung. **3** In den Achterkabinen setzt sich das helle, geräumige Ambiente des Salons fort. Große Fenster sorgen für viel Tageslicht, hochwertige Stoffe setzen edle Akzente.

Everything is perfect, for perfect holidays: **1** Let the HANSE 458 free you and become your home away from home, with its exceptional atmosphere of well-being, special colour scheme and intelligent lighting. Space can be used flexibly to satisfy every wish. **2** A beautiful design and indirect lighting turn the bathroom into a space to unwind. **3** The bright, spacious ambience of the saloon carries over into the aft cabin. Large windows illuminate the stylish interior, while high-quality fabrics add an elegant touch.



LIGHT & LUXURIOUS

THE MASTER CABIN



Sich ungestört zurückziehen, die Ruhe genießen. Nirgendwo geht das besser als in der komfortablen Eignerkabine. Sie ist voll ausgestattet mit einem en suite Designer-Bad und bietet wunderbare Annehmlichkeiten, wie ein elegantes Inselbett, viel Ablage- und Stauraum sowie einen fantastischen Ausblick durch große Skylights und Rumpffenster.

Leave the raw excitement up on deck for a moment and enjoy withdrawing into the peace and quiet of this supremely comfortable master cabin. Offering a pure oasis of calm and comfort, the cabin is fully equipped with an en-suite designer bathroom, an elegant island bed, generous shelving and stowage space, as well as fantastic views through extensive skylights and hull windows.



Wohin Sie auch segeln – Ihre HANSE ist ein Unikat. Entscheiden Sie die Farbe des Rumpfes und auf welchen Polstern Sie Ihren Sundowner genießen. An Deck bestimmen Sie über die technische Ausstattung Ihrer HANSE-Yacht. Auch das Interieur trägt Ihre Handschrift. Genießen Sie die Freiheit auf See in einem coolen Loft oder umgeben von maritimer Eleganz. Wählen Sie einfach die für Sie perfekten Materialien und exklusiven Ausstattungen aus!

Wherever you sail – your HANSE is one of a kind. You choose the colour of the hull and which upholstery you would like to catch your eye. On deck, the decision of which technical equipment to include on your HANSE yacht is all yours. The interior also carries your signature. Enjoy the freedom in the open sea in a modern loft atmosphere or surrounded by maritime elegance. High-quality materials and exclusive fittings await you.



INDIVIDUAL

CUSTOMISATION

 458



Segeln Sie am liebsten zu zweit, mit der Familie oder im großen Freundeskreis? Die Raumaufteilung Ihrer HANSE 458 können wir individuell auf Ihre Wünsche zuschneiden. Sie haben die Wahl zwischen dem klassischen Standardlayout oder einem maßgeschneiderten Kabinen-Konzept für mehr oder weniger Gäste an Bord.

Do you prefer to sail with loved ones, your family or with a group of friends? The below-deck layout of your HANSE 458 can be adapted to your individual needs and desires. You can choose between the classic layout and a tailor-made cabin concept for many or just a few guests on board.

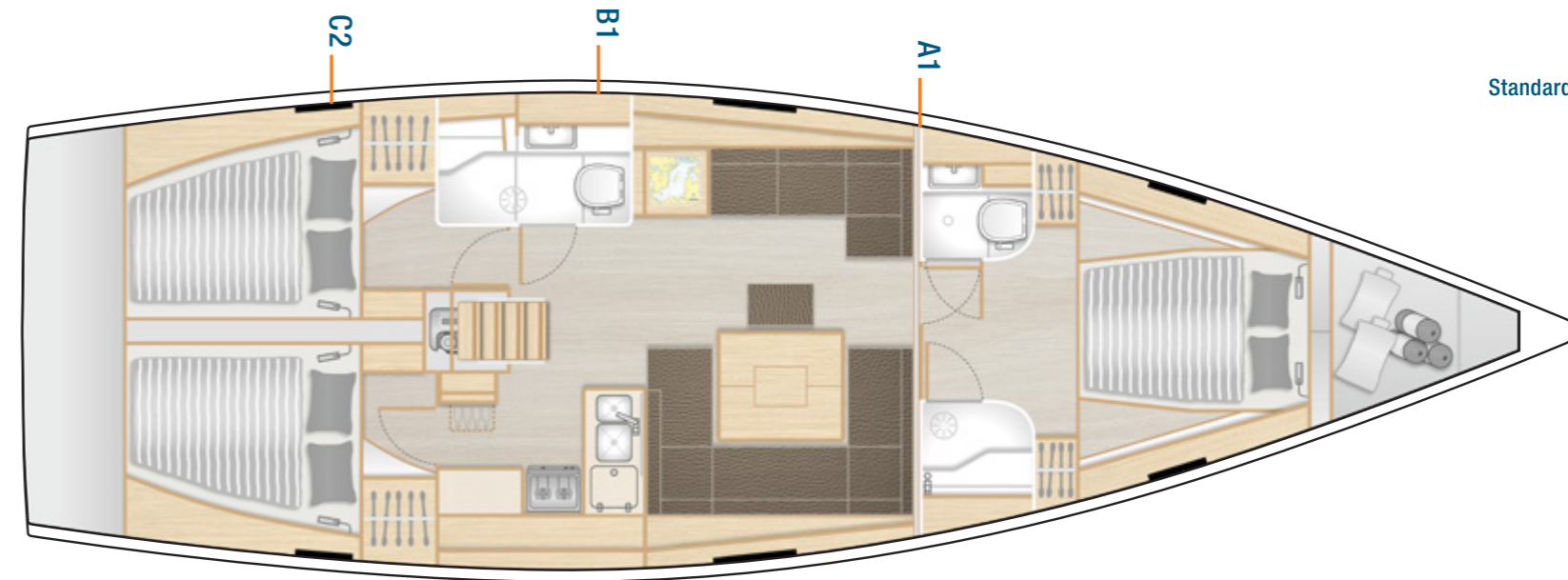
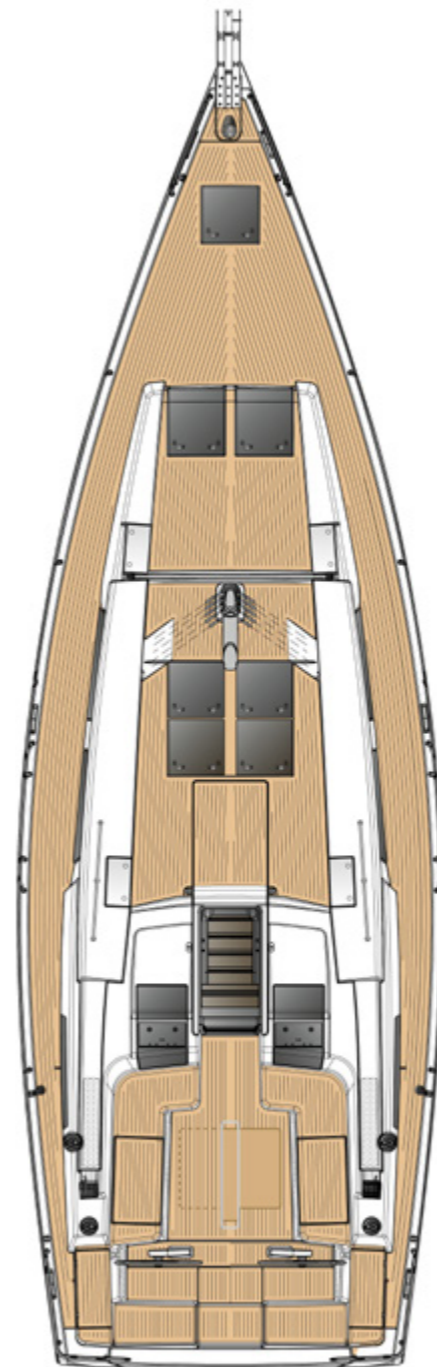

Standard

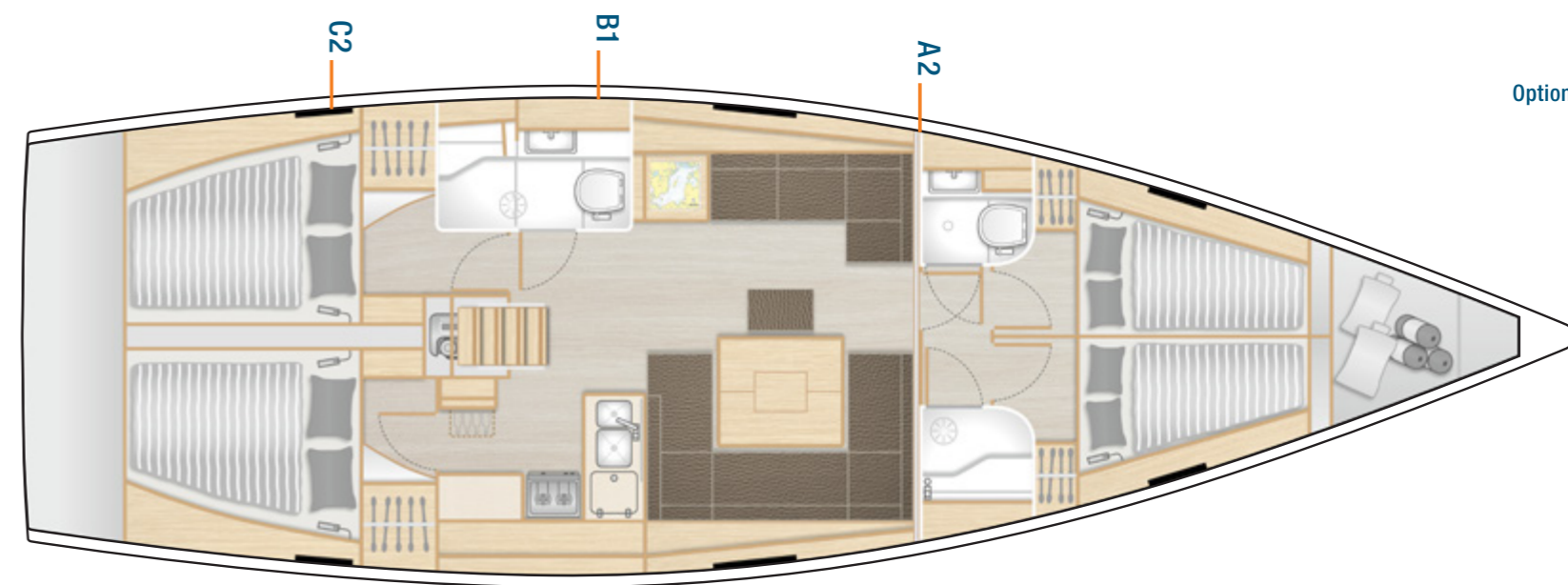

Option

CABIN CONCEPT

INDIVIDUAL



TEAK DECK



TEAK & SYNTHETIC TEAK

Options: 1 Teak · Synthetic Teak: 2 Teak Black
 3 Teak Grey 4 Teak White 5 Scrubbed Black
 6 Scrubbed Grey 7 Scrubbed White 8 Weathered Black 9 Weathered White

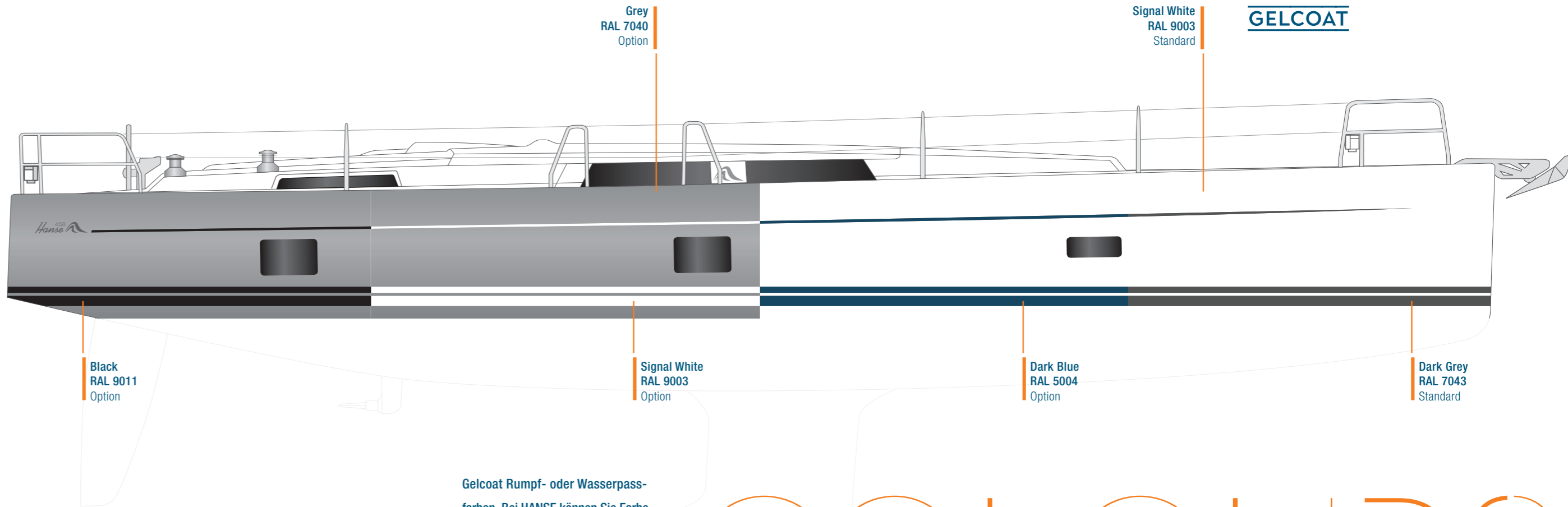

Gelcoat Rumpf- oder Wasserpassfarben. Bei HANSE können Sie Farbe bekennen, aus einer Vielfalt an Möglichkeiten.

Gelcoat hull and waterline colours. At HANSE, you can select your individual colour for your new yacht.

COLOURS HULL & WATERLINE

STYLE

CREATE YOUR OWN LIFE

Eine individuelle Yacht für eine einzigartige Persönlichkeit. Wer eine HANSE segelt, will das Besondere. HANSE bietet Ihnen die Möglichkeit, dieses Besondere ganz persönlich zu gestalten. Ihrer Fantasie sind kaum Grenzen gesetzt. Unsere Experten helfen Ihnen gerne bei der Auswahl.

Your own individual yacht for your unique personality. Discerning connoisseurs sail HANSE, as we offer you the chance to express your style personally. There are no limits to how creative you can be. Our experts are happy to support you in choosing the perfect accents.



CUSHIONS FOR COCKPIT . SUNBED . HELMSMAN SEATS . WET BAR

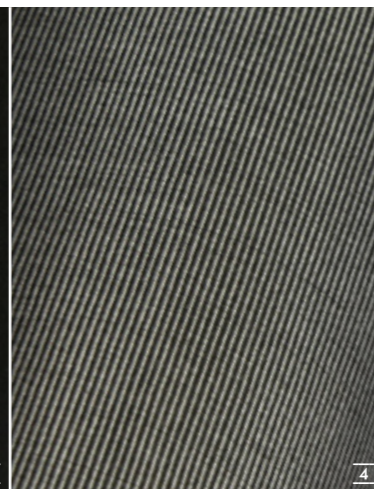
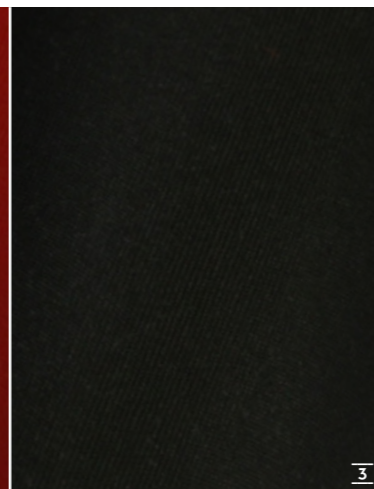
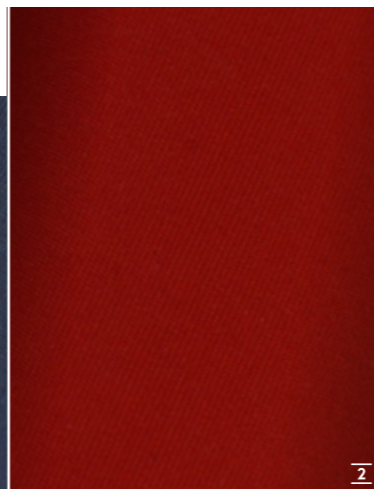

Options:

1 Dark Blue 2 Red 3 Black 4 Dark Grey 5 Light Grey 6 Cream

LAZY BAG . BIMINI . SPRAYHOOD . COVER . CANOPY CANVAS WINDSCREEN & COCKPIT

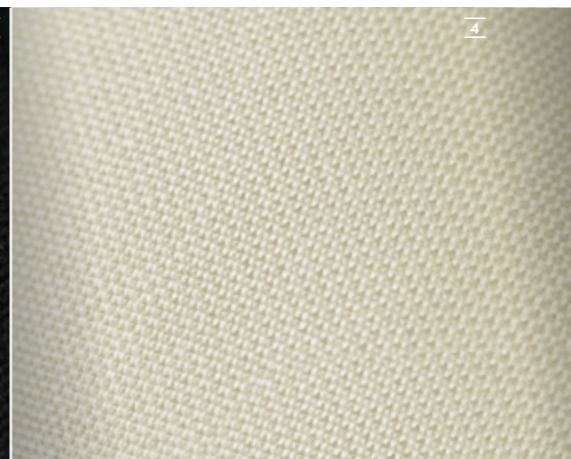
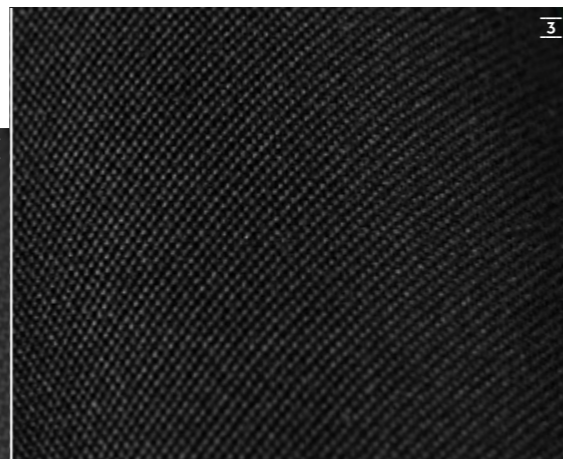
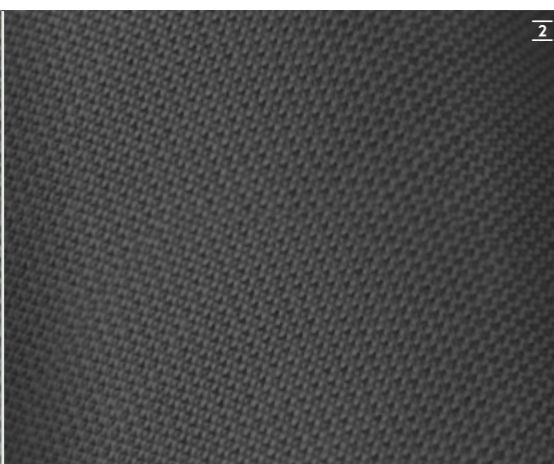

Options: 1 Light Grey 2 Dark Grey 3 Black 4 Cream

FURNITURE

Marine optimized real wood veneer from ALPI.

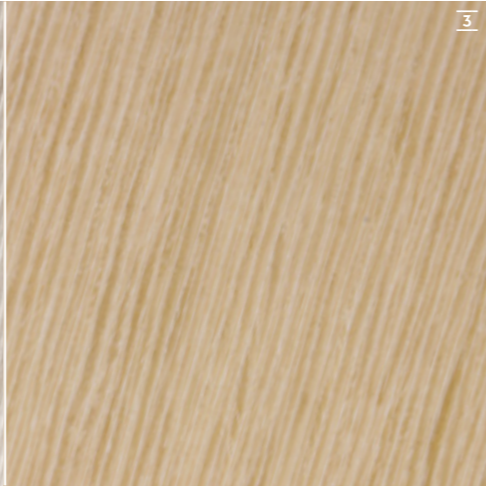

Standard: **1** Mahogany Style Satin Varnish · Options: **2** Canadian Chestnut Satin Varnish **3** French Oak



CUPBOARD FRONTS

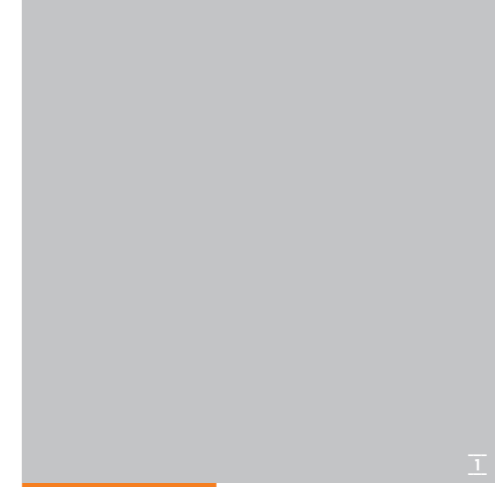

Options: **1** Pearl Grey **2** Dove Grey

FLOORBOARDS

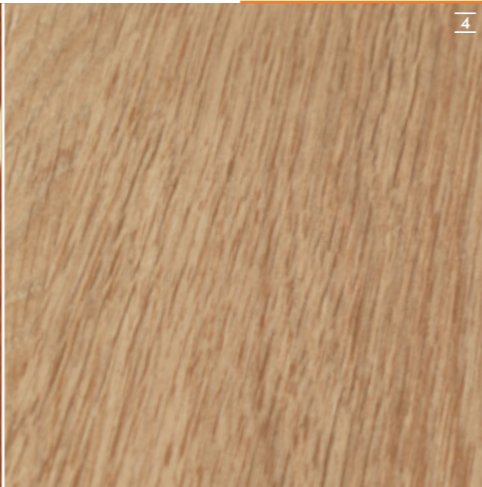
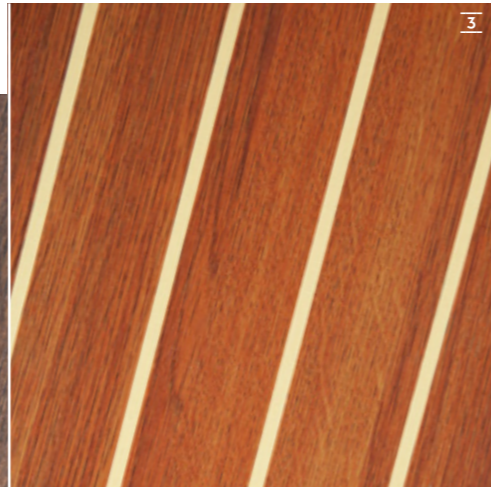
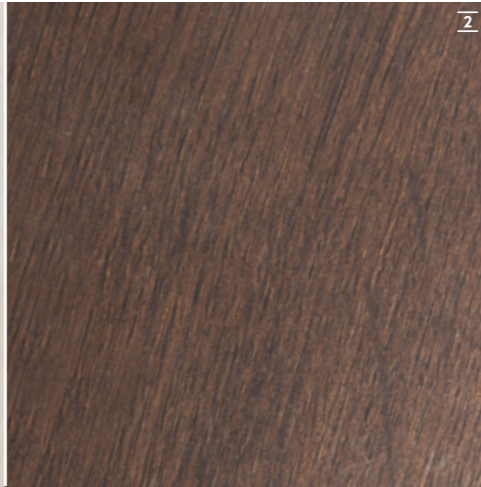
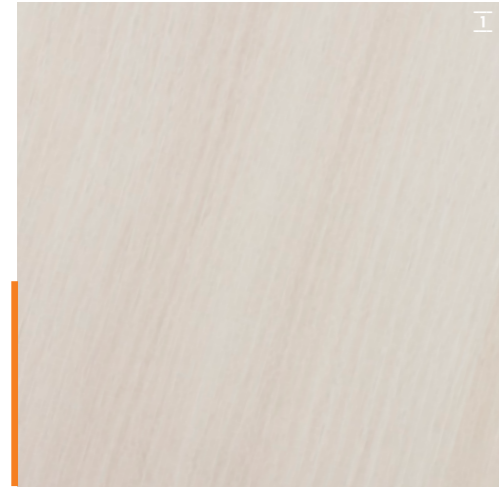

Standard: **1** Acacia · Options: **2** Noce Nero **3** Classic Stripes **4** Delight Oak

WORKTOP GALLEY

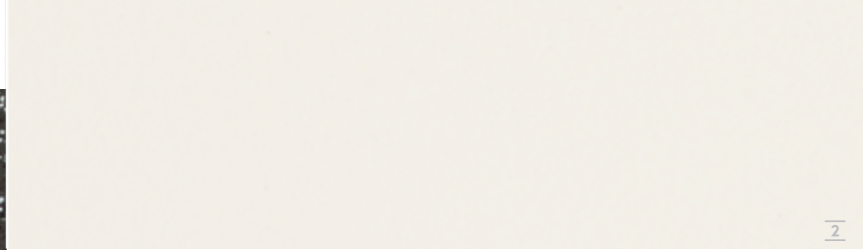
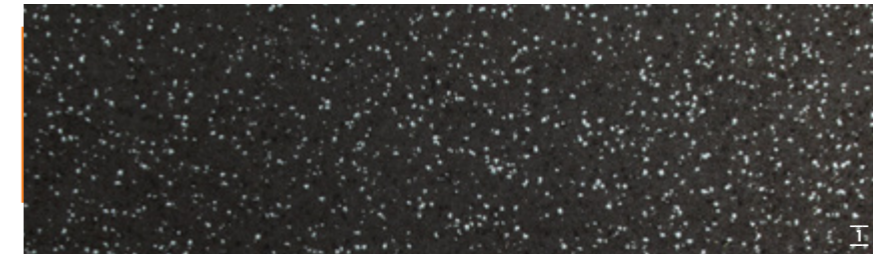

Standard: **1** Black Quartz · Option: **2** Seashell White

FABRICS INTERIOR

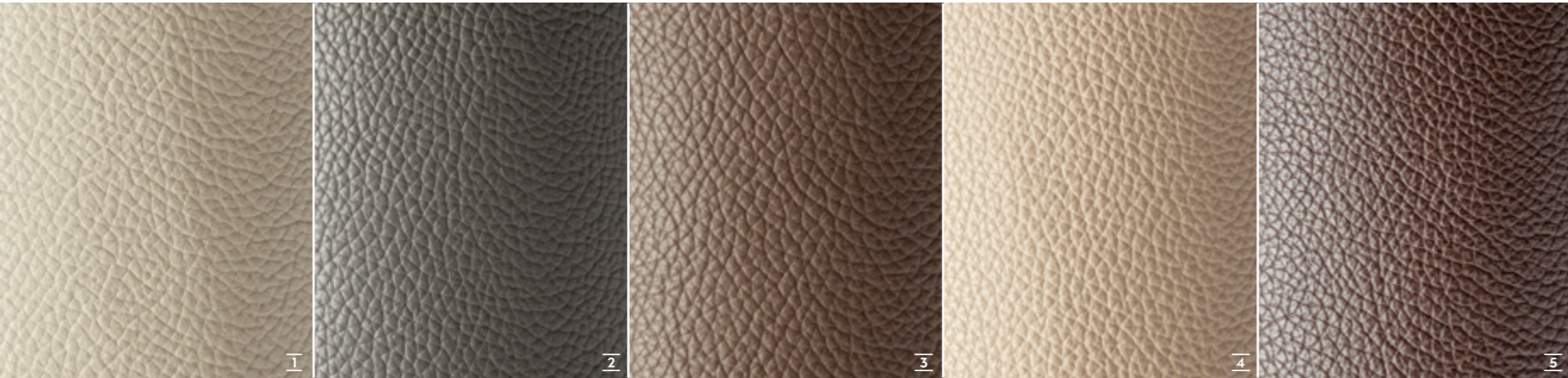

PORTOFINO LEATHER

Options: **1** Ivory **2** Basalt **3** Mud **4** Clay **5** Chocolate



MONTE CARLO

Standard: Cream



MONACO

Options: **1** Almond **2** Bronze **3** Rock Island
4 Black Truffle **5** Husky



SORRENTO

Options: **1** Taupe **2** Silver
3 Stone **4** Charcoral **5** Denim

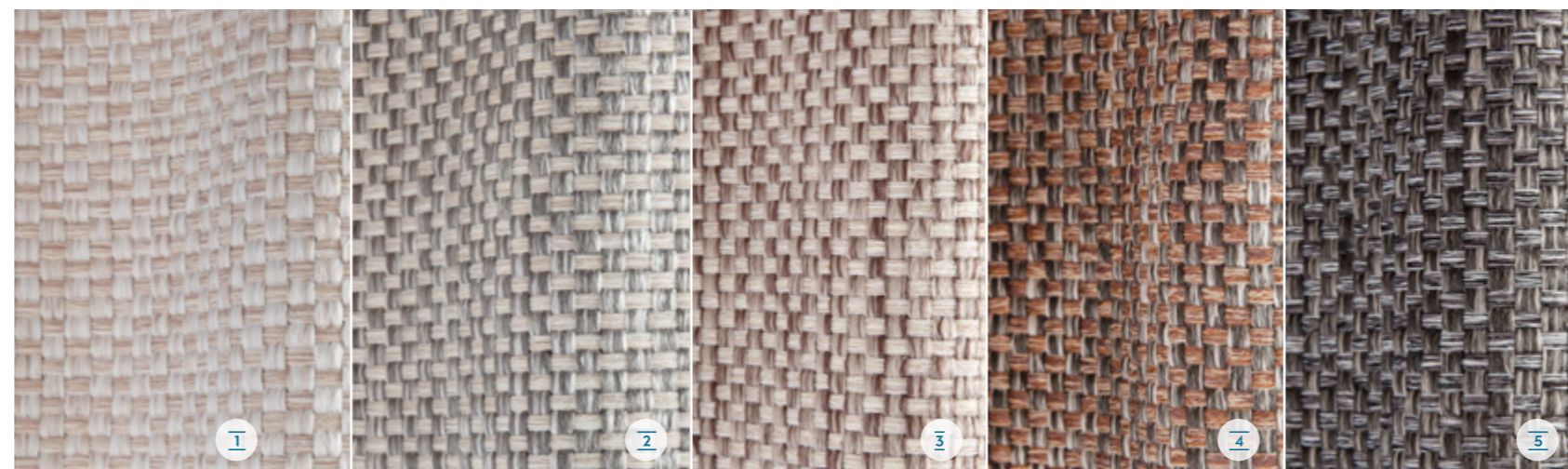

FLORENCE

Options: **1** Cliffside **2** Glacier
3 Oyster **4** Muscat **5** Graphite



1 Coast Gold 2 Red 3 Dark Blue 4 Ocean Blue 5 Black 6 Grey 7 Natural
 And many more colours - it's your choice.

GENNAKER

HANSE CROSSOVER SAIL

- Segel Performance ab 5 Knoten Wind
- Segelfläche 93,00 m² (ca. 1.001 sq ft)
- Größtes Windrichtungsspektrum seiner Klasse
- Grüne Alternative zum Motor
- Idealer Zusatz zur Selbstwendefock
- Zweites Vorstag

- Sailing performance from 5 kn wind speed
- Sail area 93.00 m² (approx. 1,001 sq ft)
- Largest wind angle range in its class
- Green alternative to the engine
- Ideal complement to the self-tacking jib
- Additional forestay

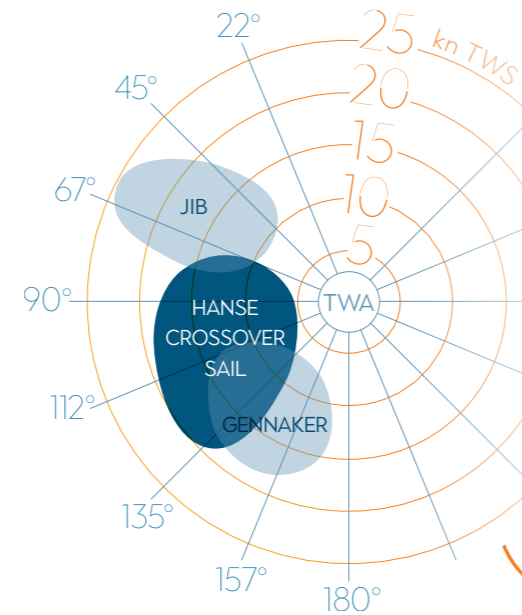

SAIL



FAST CRUISING LAMINATE SAILS

FAST CRUISING LAMINATE SAILS

- Höhere Formstabilität für bessere Segeleigenschaften
- Längere Lebensdauer für den ambitionierten Fahrtensegler
- Für HANSE Yachten exklusiv entwickelt von Jesper Bank

- Increased stability for high performance
- High durability for ambitious cruising
- Exclusive Design by Jesper Bank for HANSE yachts



ELVSTRÖM FCL 5-LAYER PERFORMANCE TRIOPTIMAL SAILS

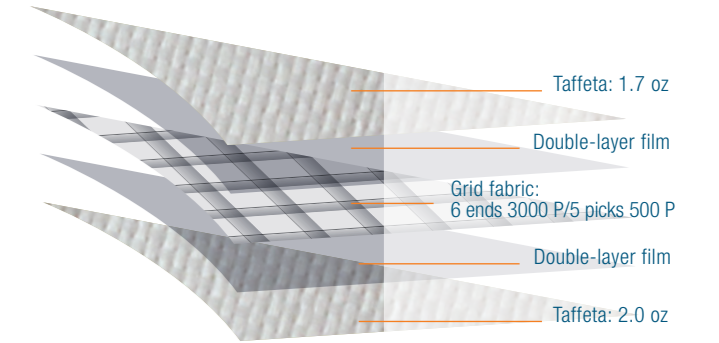

PERFORMANCE SAILS

NAVIGATION PACKAGE B&G



B&G Zeus³S 9" chart plotter
starboard at helm station



B&G VHF V60
at chart table,
incl. wireless remote handset H60



B&G Autopilot
with Triton² control unit
and Precision 9 compass



2 B&G Triton² multifunction displays
in cockpit,
incl. transducer (wind/speed/depth/temperature)



2 instrument pods | VHF preparation with antenna and splitter for FM and AIS

UPGRADE H5000 INSTRUMENTS



2 B&G H5000 multifunction displays
incl. transducer (wind/depth/speed/temperature)
B&G Autopilot with H5000 control unit and
precision 9 compass
B&G CPU Hydra computer
BGoFree WiFi adapter

UPGRADE SECOND CHART PLOTTER



B&G Zeus³S 9" chart plotter
port side at helm station

TV PACKAGE SALOON

TV preparation | Flat-screen LED TV

DVB-T2 antenna for TV

ENTERTAINMENT PACKAGE SALOON & COCKPIT



FUSION MS-RA70N Multimedia Radio
with Bluetooth®
for saloon und cockpit

Fusion MS-AB206 Subwoofer
with integrated amplifier in saloon

Wireless charging



FUSION MS-NRX Remote Control
– Watertight control of all functions
in cockpit
– Control of iPod/iPhone music library
– Display of speed, depth, wind and
GPS via NMEA 2000 interface



4 high-end 2-way speakers
in saloon
2 high-end 2-way speakers
in cockpit
– Shock resistant, watertight



FUSION MS-AV755 Multimedia radio
with Bluetooth® and CD/DVD player,
for saloon und cockpit
FUSION wireless link
remote control via mobile devices

UPGRADE PREMIUM RADIO



FUSION MS-AV755 Multimedia radio
with Bluetooth® and CD/DVD player,
for saloon und cockpit
FUSION wireless link
remote control via mobile devices

HANSE PACKAGES

X^{MORE}TRAS

458

Die Optionsvielfalt von HANSE gibt Ihnen mehr Freiheit – räumlich und gestalterisch. Hier finden Sie ausgesuchte Extras für Ihre HANSE 458.

The variety of individual options at HANSE give you more freedom – spatially and artistically.



1 praktisches Kühlfach zentral im Cockpittisch 2 große Badeplattform mit Teak 3 doppelter Ankerarm mit Anschlagmöglichkeit für Gennaker und Crossover Sail 4 stilvoll elegante Cockpitpolster für noch mehr Komfort 5 LEWMAR 40 ST EVO Genuawinschen für perfektes Handling von Gennaker und HANSE Crossover Sail 6 Carbonite Steuerräder im Y-Spoke Design 7 edles Teakholz oder strukturechtes Synthetik-Teak für Deck und Cockpit in verschiedenen Farbtönen 8 Lazy-Bag mit Lazy-Jacks in verschiedenen Farben

1 Convenient cooler integrated in the centre of the cockpit table 2 Large teak-decked bathing platform 3 Double stem fitting with tack point for the gennaker and HANSE Crossover Sail 4 Stylish, elegant cockpit upholstery for even more comfort 5 Lewmar 40ST EVO® genoa winches for perfect handling of the gennaker and HANSE Crossover Sail 6 Carbonite wheels featuring a Y-spoke design 7 Elegant teak wood or genuine structured synthetic teak for the deck and cockpit, featuring different colour tones 8 Lazy cradle with lazy jacks in various colours

ORIGINAL ACCESSORIES



MADE IN
GERMANY
SINCE 1990

Breaking rules, setting trends – für uns ist das mehr als ein kluger Satz. Es ist eine Haltung, die wir mit jedem neuen Boot Wirklichkeit werden lassen. Eine Haltung, die Sie auf jeder Seemeile fühlen, erleben und genießen werden – und über die Sie auf den nächsten Seiten mehr erfahren.

Breaking rules, setting trends. To us, this is more than just a catchphrase. It is a commitment we make a reality with each finished yacht. A commitment you can feel, experience and enjoy sea mile by sea mile. Discover more about this on the following pages.



BREAKING RULES SETTING TRENDS

“ A blend of striking design, innovative features and very keen pricing has made this yard a real success story. ”

Sailing Today Magazine

Bis heute gewannen HANSE Yachten insgesamt mehr als 62 internationale Auszeichnungen.

To date, yachts made by HANSE have won more than 62 international awards.



OVER 60 ft

Jede fertiggestellte HANSE Yacht setzt Maßstäbe in technologischer Innovation, einfachem Handling und höchster Individualität. Das gilt bis in die höchste Bootsbaubau-Klasse

“ The HANSE 675 is a dream boat. Putting up the sails becomes a joyful experience: You can easily catch the wind and adjust to the wind strength. Mooring and anchoring



Bei berühmten Regatten feiern HANSE Yachten immer wieder große Erfolge, z.B. auf der Atlantic Rally for Cruisers, der Copa del Ray oder der Nordseewoche.

Time and time again, HANSE yachts achieve great successes in legendary regattas such as the Atlantic Rally for Cruisers, the Copa del Ray or the Nordseewoche.

“ Only boats with outstanding performance characteristics deserve the name HANSE. ”
Dr Jens Gerhardt | CEO HANSE

HANSE entwirft seine Yachten in Zusammenarbeit mit den Weltklasse-Designern judel/vrolijk & co. Die erste gemeinsame Entwicklung wurde sofort zum Klassiker: die HANSE 371.

HANSE create their yachts in cooperation with world-renowned boat designers judel/vrolijk & co. Our first joint development became an instant classic: the HANSE 371.



371
Hanse

“ HANSE has a tireless passion for new ideas. It's a pleasure to work with them. And a challenge, too. ”
Rolf Vrolijk

CONTINENTS

In allen Erdteilen schwören Segelbegeisterte auf HANSE. Das Händlernetz der weltweit zweitgrößten Segelyachtwerft liefert in 70 Länder.

All over the world, sailing enthusiasts favour HANSE yachts. The international dealer network of the world's second-largest sailing yacht manufacturer delivers to 70 countries.

“ At world's end, HANSE yachts are as highly coveted as in Germany. ”
Anthony Bishop | Dealer, Australia

über 60 Fuss. | Each manufactured HANSE yacht sets a new benchmark in technical innovation, easy handling and extreme individuality. This also holds for the largest class in sailboat building over 60 feet.

are also one button push away. ” Philippe Fornier | HANSE 675 owner



HANSE steht für Innovationen, die einfach überraschen – und auf die man nie wieder verzichten will. Unser neuestes Beispiel: der E-MOTION RUDDER DRIVE der HANSE 315.

HANSE is best known for inventions that are surprising and indispensable at the same time. The latest example is the E-MOTION RUDDER DRIVE of the HANSE 315.

“Yachts by HANSE are the real 21st century boats. They shape the present and show the way into the future.”

Raoul Bajorat | Head of Development HANSE



“You won't find any production yacht more customisable than a HANSE.”

Maxim Neumann | Sales Director HANSE

Unsere Vielfalt an Polsterstoffen, Möbelhölzern oder Teppichen ergibt für den Eigner tausende Einrichtungsvarianten. Eine so große Auswahl ist einzigartig im Markt.

Thanks to the wide range of upholstery, furniture wood and carpets, we offer thousands of individual furnishing arrangements. A wide choice like this is unique in the market.

89



Bei HANSE arbeiten 890 segelbegeisterte Profis Hand in Hand. Unterstützt von modernsten Fertigungsprozessen. Getrieben von absoluter Hingabe zum Beruf.

At HANSE, 890 dedicated sailing enthusiasts work together hand in hand. Supported by cutting-edge production processes. Driven by total commitment to their profession.

“We and our customers are kindred souls: There is nothing we enjoy more than a flawlessly engineered sailing yacht.”

Pascal Kuhn | Product Marketing HANSE

Anfang der Neunziger revolutionierte die erste, je gebaute HANSE Yacht den Bootsmarkt: Sie wurde als erstes Serienboot mit integrierter Selbstwendefock ausgestattet.

In the early 1990s, the very first HANSE started a revolution in boat building. It featured the first integrated self-tracking jib ever produced in series.

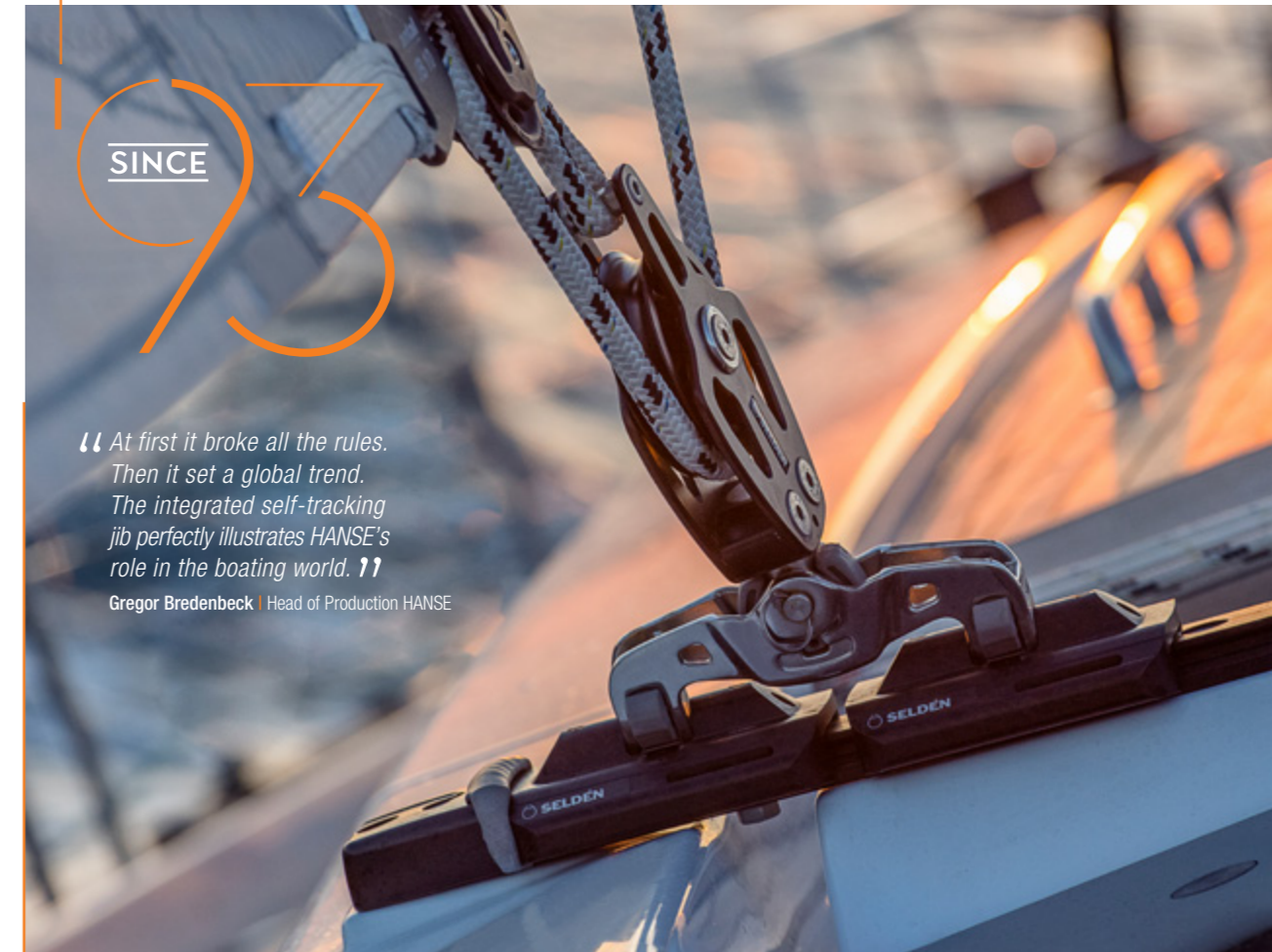

“At first it broke all the rules. Then it set a global trend. The integrated self-tracking jib perfectly illustrates HANSE's role in the boating world.”

Gregor Bredenbeck | Head of Production HANSE

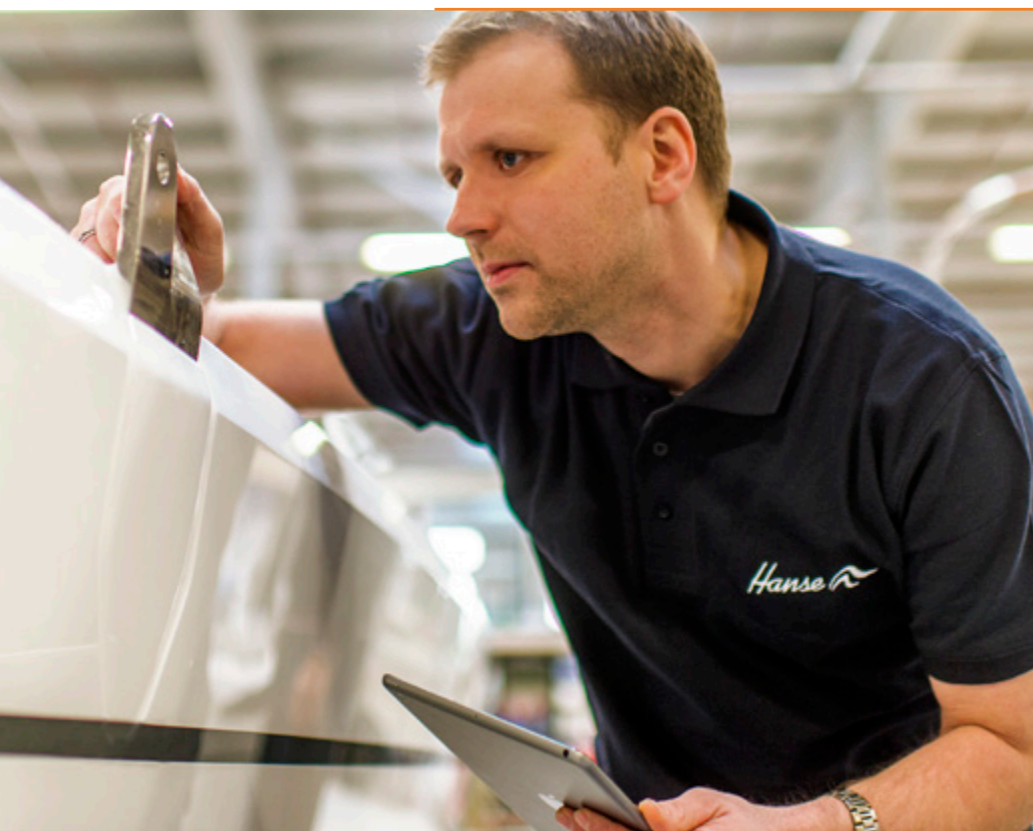

Beeindruckend in jedem Detail, überwältigend als Gesamtwerk: HANSE-Yachten sind weit mehr als die perfekt abgestimmte Verbindung von Design und modernsten Technologien. Sie repräsentieren die Erfahrung und das Wissen der HANSE Ingenieure. Ihre Leidenschaft zum Yachtsport lassen sie in unvergleichlicher Präzision und Akribie in jeder HANSE Wirklichkeit werden.

Impressive in every detail, HANSE yachts are masterpieces made to take your breath away. They are far more than a perfectly harmonised ensemble of design and the most modern technologies. They reflect the experience and know-how of HANSE engineers. Their passion for yachting can be felt in the unmistakable precision and meticulous detailing found in every HANSE.



HANSE
ENGINEERING
HANSE

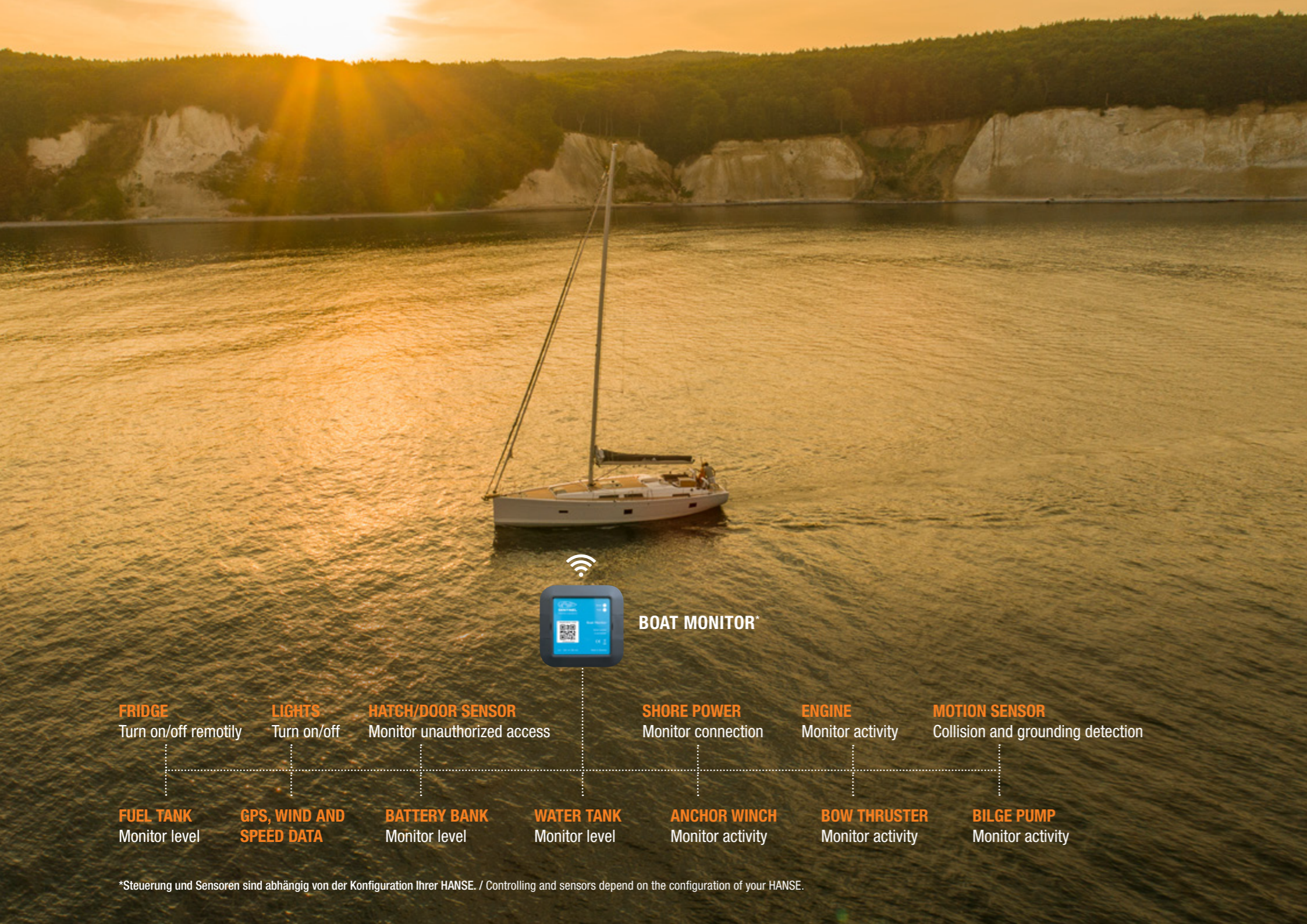

MY HANSE SAFETY CLOUD

Alles unter Kontrolle. Mit der MyHanse Safety Cloud haben Sie vollen Zugriff auf alle wichtigen Daten Ihrer HANSE. Jederzeit und von jedem Ort aus. Intelligente Anwendungen wie BoatMonitoring, eLogBook und eServiceBook ermöglichen es Ihnen, Ihre Yacht unkompliziert und bequem zu überwachen, automatisch Logbuch zu führen und sämtliche Wartungstermine stets im Blick zu behalten.

Everything under control. With the MyHanse Safety Cloud you gain full access to all important data of your HANSE. At any time and any place. Intelligent applications as BoatMonitoring, eLogBook and eServiceBook allow you to supervise your yacht easy and comfortable, to keep the logbook automatically up to date and to keep an eye on all maintenance dates.



MANUALS

Alle Handbücher und Anleitungen in einer App.
All manuals and instructions within one app.



BOAT MONITOR*

- | | | | | | |
|---------------------------------------|---------------------------------|---|--|---|---|
| FRIDGE
Turn on/off remotely | LIGHTS
Turn on/off | HATCH/DOOR SENSOR
Monitor unauthorized access | SHORE POWER
Monitor connection | ENGINE
Monitor activity | MOTION SENSOR
Collision and grounding detection |
| FUEL TANK
Monitor level | GPS, WIND AND SPEED DATA | BATTERY BANK
Monitor level | WATER TANK
Monitor level | ANCHOR WINCH
Monitor activity | BOW THRUSTER
Monitor activity |
| | | | | | BILGE PUMP
Monitor activity |

*Steuerung und Sensoren sind abhängig von der Konfiguration Ihrer HANSE. / Controlling and sensors depend on the configuration of your HANSE.

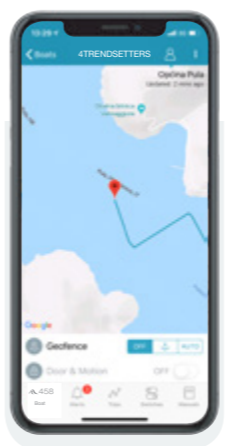

POSITION

Verfolgen Sie Ihre Position in Echtzeit.
Track your position in real-time.

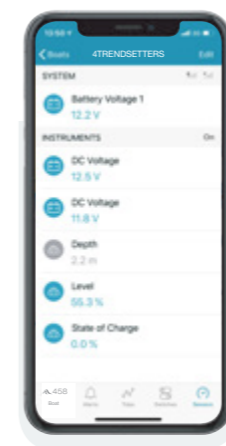

SENSORS

Überwachen Sie Ladestände und Geräte.
Monitor your charge levels and devices.

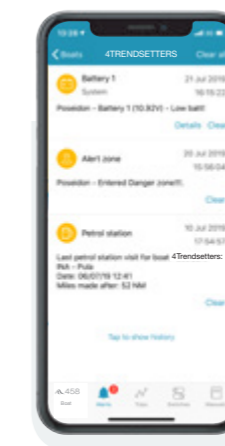

ALARMS

Push-Nachrichten bei aktuellen Ereignissen.
Push notifications on current events.

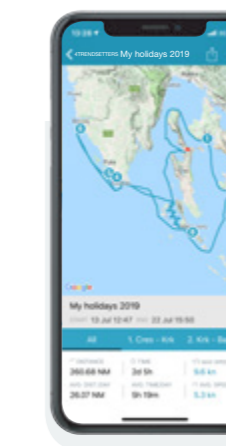

TRIP LOG

Teilen Sie Ihre geloggtten Törns mit Freunden.
Share your cruises and track data with friends.

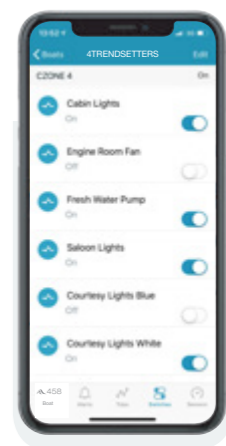

CONTROL

Bedienung elektronischer Geräte per Fernsteuerung.
Operate your electronic devices by remote control.

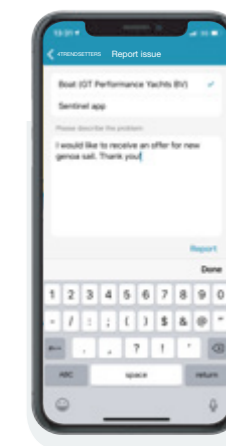

LIFE REPORT

Direkter Händler Kontakt für schnelle Hilfe.
Direct contact to your dealer for quick help.

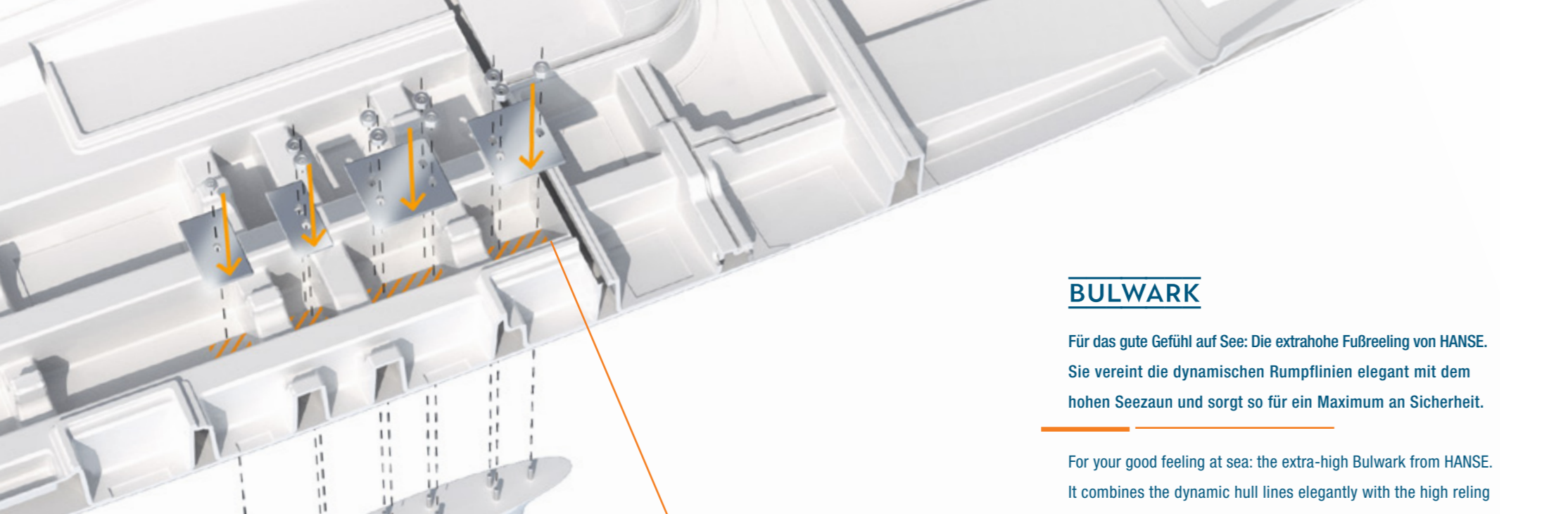

BULWARK

Für das gute Gefühl auf See: Die extrahohe Fußreeling von HANSE. Sie vereint die dynamischen Rumpflinien elegant mit dem hohen Seezaun und sorgt so für ein Maximum an Sicherheit.

For your good feeling at sea: the extra-high Bulwark from HANSE. It combines the dynamic hull lines elegantly with the high railing and thus ensures a maximum of safety.

KEEL HULL CONNECTION

Safety first. Die Kielplatten liegen sicher in einem ultrafesten Bett aus Epoxidharzkleber. Dadurch ist der Kiel direkt in der mächtigen Bodenstruktur verankert. Die Kiel-Bolzen inklusive Scheiben und Muttern sind aus Edelstahl gefertigt.

Safety first. The keel plates lie securely in an ultra-strong bed made of epoxy resin. This means that the keel is directly anchored in the powerful floor structure. The keel bolts, including discs and nuts, are made of stainless steel.

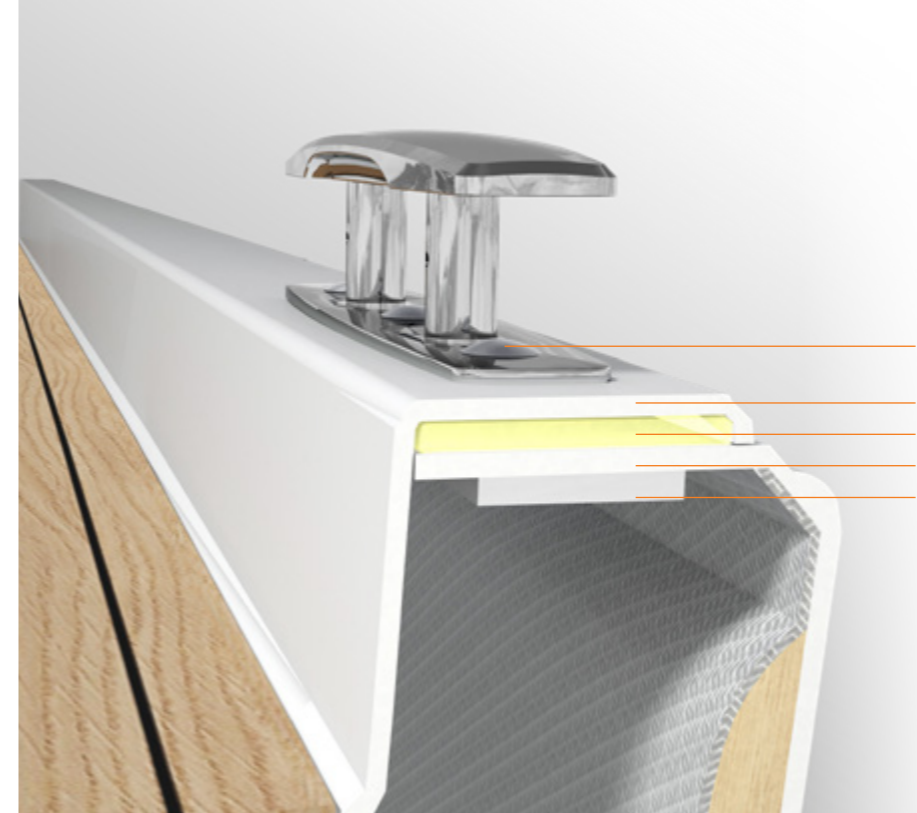

Stainless steel bolts

Deck

Best formulated performance glue

Hull

Threaded aluminum plate

HULL-DECK CONNECTION

In Zusammenarbeit mit judel/vroljik & co hat HANSE eine spezielle Deck-Rumpf-Verbindung entwickelt, die deutlich über den allgemeinen Anforderungen liegt. Neben dem Einsatz von hochfestem Polyesterklebharz, werden Deck und Rumpf mithilfe von Bolzen in den Klampen zusätzlich verankert und ergeben eine steife, torsionsfreie Yacht mit sportlichem Charakter.

In collaboration with judel/vroljik & co, HANSE has developed a special hull-deck connection which goes well beyond all standard requirements. In addition to the use of highly robust polyester bonding resin, the deck and hull are anchored with the use of high-strength bolts in the cleats. This results in a stable, torsion-free yacht with a sporty character.



SANDWICH CONSTRUCTION

Die HANSE 458 wird im hochwertigen Sandwichverfahren gebaut. Der Rumpf besteht aus mehreren Schichten ausgewählter Materialien und ist bis ins Detail genau berechnet. Er ist dadurch besonders leicht und dank der äußeren Vinylester-Laminatschicht vollkommen resistent gegen Osmose.

The HANSE 458 is constructed using the high-quality sandwich process. The hull features several layers of select materials and is precisely calculated in every detail. It is particularly lightweight and, thanks to the exterior vinylester layer, completely resistant to osmosis.

GRP laminate

Core-Mat

GRP laminate

Vinylester

Gelcoat





458 SPECIFICATIONS



Beam 4.38 | 14'4"

LOA 14.04 m | 46'1"

LOA		14.04 m	46'1"
Hull length		13.55 m	44'5"
LWL		12.20 m	40'0"
Beam		4.38 m	14'4"
Draft			
L-keel medium		2.23 m	7'4"
L-keel shallow		1.87 m	6'2"
Displacement			
L-keel medium	approx.	11.70 t	25,794 lb
L-keel shallow	approx.	12.10 t	26,675 lb
Ballast			
L-keel medium	approx.	3.38 t	7,447 lb
L-keel shallow	approx.	3.74 t	8,245 lb
Engine Diesel			
standard	approx.	57 PS	57 HP
option	approx.	80 PS	80 HP
Fuel tank	approx.	210 l	55 gal
Fresh water	approx.	450 l	119 gal
CE Certificate	A -10 ocean		
Design	judel/vrolijk & co		
Interior	HanseYachts Design		
<hr/>			
Mast length above WL	approx.	20.60 m	67'7"
Total sail area	approx.	103.00 m ²	1,109 sq ft
Main sail			
standard	approx.	60.00 m ²	646 sq ft
furling	approx.	48.00 m ²	517 sq ft
Self-tacking jib	approx.	43.00 m ²	463 sq ft
Crossover	approx.	93.00 m ²	1,001 sq ft
Gennaker	approx.	160.00 m ²	1,722 sq ft
Rig			
I	17.80 m		58'5"
J	5.50 m		18'1"
P	17.00 m		55'9"
E	5.95 m		19'6"

All measurements are approximate. Specification and material can be changed without notice. Errors excepted.



This brochure is not contractual. The yachts depicted hardly comprise special equipment not included in the standard scope of supply. Illustrations may not correspond with current versions. Subject to alterations in design and equipment without notice and errors excepted. Photos/Illustrations: HanseYachts AG, Nico Krauss, Peter-Paul Reinmuth, Björn Willer, Jüdel/vrolijk & co, Malwin Faber, Navico, B&G, Fusion, Elnvström, Nico Martínez. Design: design-hausen.de & ulson.de | Print: Druckhaus Panzig